

<b>WORM DRIVE CLAMPS</b>	
Technical Description	2
Slotted and Solid Bands Data Tables (Zinc Plated & Stainless Steel)	3
Installation Requirements and Merchandisers	4
<b>HEAVY DUTY HOSE CLAMPS</b>	
Technical Data and Merchandisers	5
Data Table	6
Terminology	6
<b>OETIKER® 2 EAR CLAMPS</b>	
Technical Description	7
Data Table	7
Installation Procedure	7
<b>COBRA CLIPS</b>	
Technical Description and Merchandiser	8
Data Table	9
Choosing a Size	9
<b>CONTINUOUS BAND SYSTEM</b>	
Assembly Instructions	11
<b>PREFORMED CLAMPS SYSTEM</b>	
Assembly Instructions	13
<b>RUBBER / PVC LINED CLAMPS</b>	
Rubber / PVC Coated	14 -15
<b>NORMACONNECT® PIPE COUPLINGS</b>	
	16
<b>ALPHANUMERIC INDEX</b>	
	18



This page is part of a complete catalogue containing technical and safety data. All data must be reviewed when selecting a product. Pirtek reserve the right to change technical specifications without notice.

# IHC

## WORM DRIVE CLAMPS

### ZINC PLATED & STAINLESS STEEL

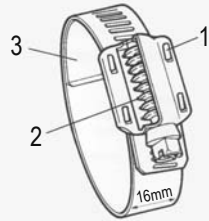

**High Torque W4  
Stainless Steel  
Slotted Band**

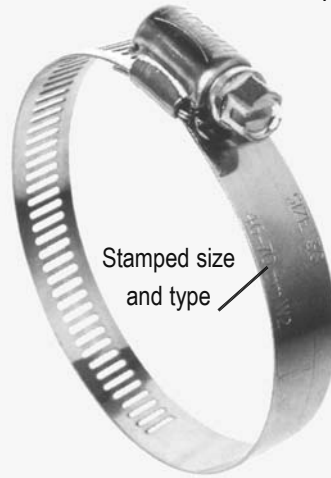

Stamped size  
and type

**Standard W4  
Stainless Steel  
Slotted Band**



**W1 Zinc Plated and  
W4 Stainless Steel  
Solid Band**

High Torque Slotted Band	Standard Slotted Band	Torro Solid Band (W1 and W4)
<p><b>Construction:</b> Wide screw housing riveted to saddle (1) in 4 spots to ensure full engagement of the 8 threads (2) One piece extended band liner (3) provides isolation of the hose from the band slots, thus preventing extrusion and shear of the hose cover through the slots Wide 16 mm x 0.7 mm thick band with 17Nm recommended tightening torque (about double that of the standard clamp) 8mm A/F slotted hex head</p>	<p><b>Construction:</b> Material (W4) and size range stamped permanently on the band to minimise errors One piece Stainless Steel housing 1/2 inch (12.7mm) wide band with low free torque Wide operating range for each size 5/16" (8mm) A/F Hex Head screw</p>	<p><b>Construction:</b> Assymmetric screw area ensures even distribution of forces and safe assembly Short screw housing saddle provides even contact pressure and improved efficiency Assymmetric extension to the housing prevents tilt of the housing when tightened Purpose built hex screw guides the emerging band end during tightening Smooth band interior (W1 clamps) or stamped interior (W4), both with rolled edges 7mm A/F slotted hex head all sizes</p>
<p><b>Materials:</b> Complies with US/SAE Standard J15087HD Full 304 Stainless Steel construction 240 hour corrosion resistance in salt spray test</p>	<p><b>Materials:</b> Complies with US/SAE Standard J1508 304 Stainless Steel band and housing with 305 Stainless Steel screw. 240 hour corrosion resistance in salt spray test</p>	<p><b>Materials:</b> All solid band clamps conform to DIN 3017 <b>Type W1:</b> Fully zinc plated mild steel (CrVI free) 144 hour corrosion resistance in salt spray test <b>Type W4:</b> AISI Grade 304 (DIN 1-4301) Stainless Steel band, housing and screw 240 hour corrosion resistance in salt spray test</p>
<p><b>Applications:</b> The strongest worm drive clamp available is suited to use in heavy duty and high pressure applications requiring a high tightening torque, and in particular where wire reinforced, silicone, plastic or tough rubber hoses are used.</p>	<p><b>Applications:</b> A wide range of automotive and general fastening applications</p>	<p><b>Applications:</b> Torro® hose clips are specially suited to industrial applications involving high mechanical loads The patented design features deliver optimum sealing performance and maximum hose protection</p>

**IHCSS STAINLESS STEEL SLOTTED BAND WORM DRIVE HOSE CLAMPS**

Product Codes		Band Dimensions mm		Slotted Hex Screw	Clamping Ø Range		Housing Dimensions mm			† Rec. Tightening Torque Nm
W4 Standard	W4 High Torque	Width W1	Thick		mm	ins	Width W2	Height H	Length L	
IHCSS6-16		7.92		6.4mm	6-16	1/4-5/8	10.2	8.4	16.3	1.36
IHCSS11-20		7.93		6.4mm	11-20	7/16-25/32	9.9	8.7	17.5	1.36
IHCSS13-23		12.7		8mm	13-23	1/2-29/32	17	11.4	29.2	3.4
IHCSS14-27		12.7		8mm	14-27	9/16-1	15.2	11.4	27.9	3.4
IHCSS17-32		12.7		8mm	17-32	11/16-1.1/4	17	11.4	29.2	3.4
IHCSS21-38		12.7		8mm	21-38	7/8-1.1/2	15.2	11.4	27.9	3.4
IHCSS21-44		12.7		8mm	21-44	7/8-1.3/4	15.2	11.4	27.9	3.4
	IHCHS25-45	16	0.7	8mm	25-45	1-1.3/4	23	13	37	17
IHCSS27-51		12.7		8mm	27-51	1-2	15.2	11.4	27.9	3.4
	IHCHS32-54	16	0.7	8mm	32-54	1.1/4-2.1/8	23	13	37	17
IHCSS33-57		12.7		8mm	33-57	1.1/4-2.1/4	15.2	11.4	27.9	3.4
IHCSS40-64		12.7		8mm	40-64	1.9/16-2.1/2	17	11.4	29.2	3.4
	IHCHS45-67	16	0.7	8mm	45-67	1.3/4-2.5/8	23	13	37	17
IHCSS46-70		12.7		8mm	46-70	1.3/4-2.3/4	15.2	11.4	27.9	3.4
IHCSS52-76		12.7		8mm	52-76	2-3	15.2	11.4	27.9	3.4
	IHCHS57-79	16	0.7	8mm	57-79	2.1/4-3.1/8	23	13	37	17
IHCSS59-83		12.7		8mm	59-83	2.5/16-3.1/4	17	11.4	29.2	3.4
IHCSS65-89		12.7		8mm	65-89	2.1/2-3.1/2	15.2	11.4	27.9	3.4
	IHCHS70-92	16	0.7	8mm	70-92	2.3/4-3.5/8	23	13	37	17
IHCSS71-95		12.7		8mm	71-95	2.13/16-3.3/4	17	11.4	29.2	3.4
IHCSS84-108		12.7		8mm	84-108	3.5/16-4.5/16	15.2	11.4	27.9	3.4
IHCSS91-114		12.7		8mm	91-114	3.9/16-4.1/2	17	11.4	29.2	3.4
IHCSS92-165		12.7		8mm	92-165	3.5/8-6.1/2	17	11.4	29.2	3.4
IHCSS105-127		12.7		8mm	105-127	4.3/4-6.1/2	15.2	11.4	27.9	3.4
IHCSS105-178		12.7		8mm	105-178	4.1/8-7	17	11.4	29.2	3.4

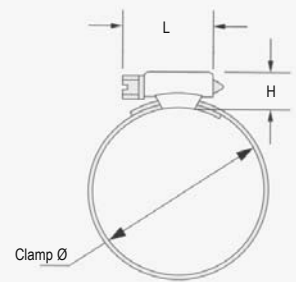

**IHCWM (ALU-ZINC) & IHCWS (STAINLESS STEEL) SOLID BAND TORRO® WORM DRIVE HOSE CLAMPS**

Product Code		Band Dimensions mm			Size Range	Trade Reference	Housing Dimensions mm			† Type W1 Torque Values Nm				† Type W4 Torque Values Nm				Pack Qty
Solid Band		Width	Thickness				Width	Height	Length	Rec. Tightening	No-load (Max)	Test	Fracture (Min)	Rec. Tightening	No-load	Test	Fracture	
W1 (Alu-Zinc)	W4 (St. Steel)	All	W1	W4	mm													
Phillips Head	Slotted Head																	
IHCWM08-12	-	9	0.8	-	8-12	000	13	11	21	2.5+5	1.2	3.3	4				10	
-	IHCWS08-16	9	-	0.7	8-16	-	13	11	21	-	-	-	-	2+5	0.7	2.6	4	10
IHCWM10-16	-	9	0.8	-	10-16	M00	13	11	21	3+5	1.2	4	4.5				10	
-	IHCWS12-20	9	-	0.7	12-20	-	13	11	21	-	-	-	-	3+5	0.7	4	4.5	10
IHCWM12-22	IHCWS12-22	9	0.8	0.7	12-22	00	13	11	24	3+5	1.2	4	5.5	3+5	0.7	4	4.5	10
IHCWM16-27	IHCWS16-27	12	0.8	0.7	16-27	0	13	11	24	5+5	1.2	6.5	10	5+5	1	6.5	8	10
IHCWM20-32	IHCWS20-32	12	0.8	0.7	20-32	1A	13	11	24	5+5	1.2	6.5	10	5+5	1	6.5	8	10
IHCWM25-40	IHCWS25-40	12	1	0.8	25-40	1	13	11	26	5+5	1.2	6.5	10	5+5	1	6.5	8.5	10
IHCWM30-45	IHCWS30-45	12	1	0.8	30-45	1X	13	11	26	5+5	1.2	6.5	10	5+5	1	6.5	8.5	10
IHCWM35-50	IHCWS35-50	12	1	0.8	35-50	2A	13	11	26	5+5	1.2	6.5	10	5+5	1	6.5	8.5	10
IHCWM40-60	IHCWS40-60	12	1	0.8	40-60	2/2X	13	11	26	5+5	1.2	6.5	10	5+5	1	6.5	8.5	10
IHCWM50-70	IHCWS50-70	12	1	0.8	50-70	3	13	11	26	5+5	1.2	6.5	10	5+5	1	6.5	8.5	10
IHCWM60-80	IHCWS60-80	12	1	0.8	60-80	-	13	11	26	5+5	1.2	6.5	10	5+5	1	6.5	8.5	10
IHCWM70-90	IHCWS70-90	12	1	0.8	70-90	4	13	11	26	5+5	1.2	6.5	10	5+5	1	6.5	8.5	10
IHCWM80-100	IHCWS80-100	12	1	0.8	80-100	-	13	11	26	5+5	1.2	6.5	10	5+5	1	6.5	8.5	10
IHCWM90-110	IHCWS90-110	12	1	0.8	90-110	5	13	11	26	5+5	1.2	6.5	10	5+5	1	6.5	8.5	10
IHCWM100-120	IHCWS100-120	12	1	0.8	100-120	-	13	11	26	5+5	1.2	6.5	10	5+5	1	6.5	8.5	5
IHCWM110-130	IHCWS110-130	12	1	0.8	110-130	6	13	11	26	5+5	1.2	6.5	10	5+5	1	6.5	8.5	5
IHCWM120-140	IHCWS120-140	12	1	0.8	120-140	-	13	11	26	5+5	1.2	6.5	10	5+5	1	6.5	8.5	5
-	IHCWS130-150	12	-	0.8	130-150	-	13	11	26	-	-	-	-	5+5	1	6.5	8.5	5
IHCWM140-160	IHCWS140-160	12	1	0.8	140-160	7	13	11	26	5+5	1.2	6.5	10	5+5	1	6.5	8.5	5
-	IHCWS150-170	12	-	0.8	150-170	-	13	11	30	-	-	-	-	5+5	1	6.5	8.5	5
IHCWM160-180	IHCWS160-180	12	1	0.8	160-180	8	13	11	30	5+5	1.2	6.5	10	5+5	1	6.5	8.5	5
IHCWM180-200	-	12	1	-	180-200	9	14.6	12.5	30	5+5	1.2	6.5	10	-	-	-	-	5
IHCWM190-210	-	12	1	-	190-210	-	14.6	12.5	30	5+5	1.2	6.5	10	-	-	-	-	5
IHCWM210-230	-	12	1	-	210-230	10	14.6	12.5	30	5+5	1.2	6.5	10	-	-	-	-	5
IHCWM230-250	-	12	1	-	230-250	11	14.6	12.5	30	5+5	1.2	6.5	10	-	-	-	-	5
IHCWM260-280	-	12	1	-	260-280	12	14.6	12.5	30	5+5	1.2	6.5	10	-	-	-	-	5
IHCWM280-300	-	12	1	-	280-300	13	14.6	12.5	30	5+5	1.2	6.5	10	-	-	-	-	5

† The significance of the tabulated Torque Values is discussed on page M8 "Terminology"



This page is part of a complete catalogue containing technical and safety data. All data must be reviewed when selecting a product. Pirtek reserve the right to change technical specifications without notice. Rev. 1.1



MERCHANDISER (Product Code: IHCMERMS-KIT) TORRO S ALU-ZINC CLAMPS (Type W1)		
Product Codes	Sizes mm	Quantity
IHCWM08-12	8-12	10
IHCWM10-16	10-16	10
IHCWM12-22	12-22	10
IHCWM16-27	16-27	10
IHCWM20-32	20-32	10
IHCWM25-40	25-40	10
IHCWM35-50	35-50	10
IHCWM40-60	40-60	10
IHCWM50-70	50-70	10
IHCWM60-80	60-80	10

The Merchandiser can also be supplied without clamps: Product Code IHCMERMS-EMPTY



MERCHANDISER (Product Code: IHCMERSS-KIT) TORRO STAINLESS STEEL CLAMPS (Type W4)		
Product Codes	Sizes mm	Quantity
IHCWS08-16	8-16	10
IHCWS12-20	12-20	10
IHCWS16-27	16-27	10
IHCWS20-32	20-32	10
IHCWS25-40	25-40	10
IHCWS30-45	30-45	10
IHCWS35-50	35-50	10
IHCWS40-60	40-60	10
IHCWS50-70	50-70	10
IHCWS60-80	60-80	10

The Merchandiser can also be supplied without clamps: Product Code IHCMERSS-EMPTY



300 mm long x 7mm  
Flexi Hex Driver  
Suits all Torro Clamps  
Product Code:  
IHC-DRIVER

Selection of the appropriate clamp

- Consider the clamping diameter ie make sure the clamp fits on the hose
- Select the correct band width to match existing system parameters
- Choose an appropriate material in terms of required corrosion resistance
- Allow for possible thermal loads
- Allow for possible mechanical loads
- Take system pressure into account, but in the context of the overall hose, clamp and spigot combination

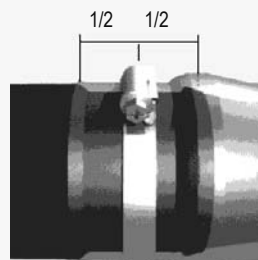

Professional hose clamp installation

- Fit the clamp in the middle of the joint
- Fit the clamp perpendicular to the joint
- Tighten the clamp as slowly as possible
- The recommended screwdriver speed is based on test results and should be observed. Note that exceeding the recommended tightening torque will not result in a proportionately higher pull-off force and / or clamping force
- Exceeding the test torque may cause permanent damage to the clamp and to the system (eg failure of the clamp after re-assembly)
- Retightening the connection once, 1-5 minutes after the first assembly, may be useful (depending on a possible relaxation of the hose material)
- Suitable assembly aids include water or a water / alcohol mixture. Soap solutions, grease and similar lubricants are NOT recommended
- The assembly tool should be applied to the clamp in a perpendicular manner
- A hexagon screwdriver, flat wrench or special assembly tool provides the safest tightening method (See IHC-DRIVER above)

# IHCT HEAVY DUTY CLAMPS



### Construction:

- Special bolt design has the spacer integrated - no more lost bolts
- Reinforced loops allow significantly higher tightening torques
- Mechanically locked closure eliminates welds and their associated contact corrosion
- Optimal hose protection through the floating bridge piece
- Robust band with rounded edges prevents injury to hose and personnel
- Flexible band exerts even pressure on the hose surface

### Materials:

All Pirtek / Norma heavy duty clamps conform to DIN 3017

#### Type W2: (Product Code IHCTG)

- 1.4016 (AISI Grade 430) Stainless Steel band
- Zinc plated steel clamping head (CrVI free)
- 72 hour corrosion resistance in salt spray test

#### Type W4: (Product Code IHCTS)

- AISI Grade 304 (DIN 1-4301) Stainless Steel band and clamping head
- 240 hour corrosion resistance in salt spray test

### Applications:

- Pirtek heavy duty clamps are particularly designed for sealing suction and pressure hoses that incorporate plastic or steel reinforcements and high Shore hardness values
- Bands can withstand extremely high tensile forces
- Suited to assembly using manual, pneumatic or electric tools
- Especially suited for use on commercial, automotive and industrial mobile equipment

MERCHANDISERS HEAVY DUTY CLAMPS  
TYPES W2 & W4  
(Product Codes: IHCMERTG-KIT & IHCMERTS-KIT) \*

Product Codes		Size Range mm	Quantity
W2	W4		
IHCTG17-19	IHCTS17-19	17-19	4
IHCTG21-23	IHCTS21-23	21-23	4
IHCTG27-29	IHCTS27-29	27-29	4
IHCTG29-31	IHCTS29-31	29-31	4
IHCTG31-34	IHCTS31-34	31-34	4
IHCTG34-37	IHCTS34-37	34-37	4
IHCTG37-40	IHCTS37-40	37-40	4
IHCTG40-43	IHCTS40-43	40-43	4
IHCTG43-47	IHCTS43-47	43-47	4
IHCTG47-51	IHCTS47-51	47-51	4
IHCTG51-55	IHCTS51-55	51-55	4
IHCTG55-59	IHCTS55-59	55-59	4
IHCTG59-63	IHCTS59-63	59-63	4
IHCTG63-68	IHCTS63-68	63-68	4
IHCTG68-73	IHCTS68-73	68-73	4
IHCTG73-79	IHCTS73-79	73-79	3
IHCTG79-85	IHCTS79-85	79-85	3
IHCTG85-91	IHCTS85-91	85-91	3
IHCTG104-112	IHCTS104-112	104-112	3
IHCTG112-121	IHCTS112-121	112-121	3

OTHER HEAVY DUTY  
CLAMPS AVAILABLE LOOSE  
TYPE W4

Product Codes	Size Range mm
IHCTS19-21	19-21
IHCTS23-25	23-25
IHCTS25-27	25-27
IHCTS97-104	97-104
IHCTS112-121	112-121
IHCTS121-130	121-130
IHCTS130-140	130-140
IHCTS140-150	140-150
IHCTS150-162	150-162
IHCTS162-174	162-174
IHCTS174-187	174-187
IHCTS187-200	187-200
IHCTS200-213	200-213
IHCTS213-226	213-226
IHCTS226-239	226-239
IHCTS239-252	239-252
IHCTS250-265	250-265
IHCTS265-278	265-278
IHCTS279-291	279-291
IHCTS291-304	291-304



\* Empty Merchandiser Product Code: IHCMERT-EMPTY



This page is part of a complete catalogue containing technical and safety data.  
All data must be reviewed when selecting a product.

Pirtek reserve the right to change technical specifications without notice. Rev. 1.1

## IHCT HEAVY DUTY HOSE CLAMPS

Steel Clamping Head W2	Fully Stainless W4	Dimensions mm		Torque Nm	
		Size Range	Band Width	Rec. Tightening	Fracture
IHCTG17-19	IHCTS17-19	17-19	18	8	15
IHCTG19-21	IHCTS19-21	19-21	18	8	15
IHCTG21-23	IHCTS21-23	21-23	18	8	15
IHCTG23-25	IHCTS23-25	23-25	18	8	15
IHCTG25-27	IHCTS25-27	25-27	18	8	15
IHCTG27-29	IHCTS27-29	27-29	18	8	15
IHCTG29-31	IHCTS29-31	29-31	18	8	15
IHCTG31-34	IHCTS31-34	31-34	18	8	15
IHCTG34-37	IHCTS34-37	34-37	18	8	15
IHCTG37-40	IHCTS37-40	37-40	18	8	15
IHCTG40-43	IHCTS40-43	40-43	18	8	15
IHCTG43-47	IHCTS43-47	43-47	20	10	20
IHCTG47-51	IHCTS47-51	47-51	20	10	20
IHCTG51-55	IHCTS51-55	51-55	20	10	20
IHCTG55-59	IHCTS55-59	55-59	20	10	20
IHCTG59-63	IHCTS59-63	59-63	20	10	20
IHCTG63-68	IHCTS63-68	63-68	20	10	20
IHCTG68-73	IHCTS68-73	68-73	25	20	30
IHCTG73-79	IHCTS73-79	73-79	25	20	30
IHCTG79-85	IHCTS79-85	79-85	25	20	30
IHCTG85-91	IHCTS85-91	85-91	25	20	30
IHCTG91-97	IHCTS91-97	91-97	25	20	30
IHCTG97-104	IHCTS97-104	97-104	25	20	30
IHCTG104-112	IHCTS104-112	104-112	25	20	30
IHCTG112-121	IHCTS112-121	112-121	25	20	30
IHCTG121-130	IHCTS121-130	121-130	25	20	30
IHCTG130-140	IHCTS130-140	130-140	30	25	45
IHCTG140-150	IHCTS140-150	140-150	30	25	45
IHCTG150-162	IHCTS150-162	150-162	30	25	45
IHCTG162-174	IHCTS162-174	162-174	30	25	45
IHCTG174-187	IHCTS174-187	174-187	30	25	45
IHCTG187-200	IHCTS187-200	187-200	30	25	45
IHCTG200-213	IHCTS200-213	200-213	30	25	45
IHCTG213-226	IHCTS213-226	213-226	30	25	45
IHCTG226-239	IHCTS226-239	226-239	30	25	45
IHCTG239-252	IHCTS239-252	239-252	30	25	45
	IHCTS250-265	250-265	30	25	45
	IHCTS265-278	265-278	30	25	45
	IHCTS278-291	278-291	30	25	45
	IHCTS291-304	291-304	30	25	45

## TERMINOLOGY USED

The *tightening torque* describes the recommended torque that is applied in order to tighten a hose clamp. It is largely defined in the DIN 3017 Standard and is measured by means of a torque wrench. However, better clamp designs incorporate design features that best convert the tightening torque into *band tension*, and so increase the tightness of a joint. Measurement of band tension (which is not covered in the Standard) provides the best objective measurement of clamping performance.

Pirtek clamping systems are manufactured in Germany by Norma®, who routinely conduct band tension measurements as part of their design and manufacturing processes.

*Fracture torque* indicates what tightening torque will result in destruction of a clamp, and provides a guide to the overall robustness of a clamp. Field servicing of mobile equipment in the absence of torque wrenches often results in manually applied tightening torques that exceed recommended tightening torques.

Quoted *test torques* are generally 30% above recommended tightening torques, and represent the maximum value at which no permanent damage to a clamp will occur through over-tightening.

*No-load* torque defines the torque needed to turn the screw without generating any clamping force. Low no-load torques with negligible deviations typify clamps that will perform well during assembly.

# IHCEC

## OETIKER® 2-EAR CLAMPS



### Construction:

- Spiral welded tube cut into rings
- Post production annealing process removes residual stress
- De-burred edges reduce hose damage

### Materials:

#### Product Code IHCEC)

- Zinc plated steel conforming to DIN 1.0338 / SAE 1008/1010
- 96 hour corrosion resistance in salt spray test (DIN 50021 / ASTM B117

### Applications:

- Fast, simple and secure installation
- Visual indication of proper closure
- Ideal for air and liquid lines at low to medium pressures
- 2-ear design provides good coupling range to suit thick walled hoses
- Can absorb thermal expansion and vibration

Product Code	Size Range mm
IHCEC3.4-5	3.1-4.1
IHCEC5-7	5-7
IHCEC7-9	7-9
IHCEC9-11	9-11
IHCEC11-13	10.8-13
IHCEC13-15	12.5-15
IHCEC15-17	14-17
IHCEC15-18	15-18
IHCEC16-19	16-19
IHCEC17-20	16.2-20
IHCEC19-22	18-22
IHCEC20-23	19-23
IHCEC22-25	21-25
IHCEC23-27	22.5-27
IHCEC25-28	24-28
IHCEC28-31	28-31
IHCEC31-34	29.3-34
IHCEC34-37	32-37
IHCEC37-40	35-40
IHCEC40-43	37.6-43
IHCEC43-46	40.6-46



Assembly Tool Product Codes:  
IHC-PINCER-N (Normal - shown)  
IHC-PINCER-S (Side)

### ASSEMBLY INSTRUCTIONS

1. Apply the pincers to one ear (either as pictured above, or from the side using a side pincer tool), and close the tool with sufficient force to draw the lower radii to a 3/4 closed position.
2. Repeat the procedure on the second ear, this time closing until obvious hose compression is evident.
3. Pinch the first ear a second time until both clamp ears appear to be sharing the compression load equally as evidenced by symmetrical 'Ω' shaped formations.

# IHCC

## 'COBRA' ONE PIECE HOSE CLIPS



### Construction:

- Self adjusting diameter provides compensation for hose diameter tolerances
- Special beading provides guidance for the band
- Colour coded bands allow easy size recognition
- A single lock-in point allows positive visual check of correct assembly
- Rounded edges to the band prevent hose damage
- Protruding tool gripping points allow simple and fast assembly using the specially designed tool

### Materials:

#### Type W4: (Product Code IHCC)

- Full AISI Grade 304 (DIN 1-4301) Stainless Steel construction
- CrVI free
- 240 hour corrosion resistance in salt spray test

### Applications:

- Low profile Cobra clips allow trouble-free exact fitting in very narrow assembly conditions
- Developed for the automotive industry
- Reopening is possible
- Ideal for small hoses
- Low pressure air
- Suction lines
- Fuel ventilation lines
- Washing machine hoses
- Trickle irrigation systems
- Pneumatic lines



Assembly Pliers

Product Code IHCC-TOOL



Product Code	Nominal dia mm	Size Range Da mm	Band Width mm	Band Colour	Pack Quantity
IHCC8-9	7.5	8-9	7	white	100
IHCC8.5-9.5	8	8.5-9.5		yellow	100
IHCC9-10	8.5	9-10		green	100
IHCC9.5-10.5	9	9.5-10.5		violet	100
IHCC10-11	9.5	10-11		black	100
IHCC10.5-11.5	10	10.5-11.5		white	100
IHCC11-12	10.5	11-12		yellow	100
IHCC11.5-12.5	11	11.5-12.5		green	100
IHCC12-13	11.5	12-13		violet	100
IHCC12.5-14	12	12.5-14		black	100
IHCC13.5-15	13	13.5-15		yellow	100
IHCC14.5-16	14	14.5-16		violet	100
IHCC15.5-17	15	15.5-17		white	100
IHCC16.5-18	16	16.5-18		green	100
IHCC17.5-19	17	17.5-19		black	100
IHCC18.5-20	18	18.5-20		yellow	100
IHCC19.5-21	19	19.5-21	violet	100	
IHCC20.5-22	20	20.5-22	8	white	100
IHCC21.5-23	21	21.5-23		green	100
IHCC22.5-24	22	22.5-24		black	100
IHCC23.5-25	23	23.5-25		yellow	100
IHCC24.5-26	24	24.5-26		violet	100
IHCC25.5-27	25	25.5-27		white	100
IHCC26.5-28	26	26.5-28		green	100
IHCC27.5-29	27	27.5-29		black	100
IHCC28.5-30	28	28.5-30		yellow	100
IHCC29.5-31	29	29.5-31		violet	100
IHCC30.5-32	30	30.5-32	9	white	100
IHCC34-36	34	34-36		violet	100
IHCC36-38	36	36-38		green	100

CHOOSING THE CORRECT SIZE

1. Slide the hose onto the spigot and measure the outside diameter Da
2. Consult the table above to find the applicable size range, and read off the corresponding Product Code

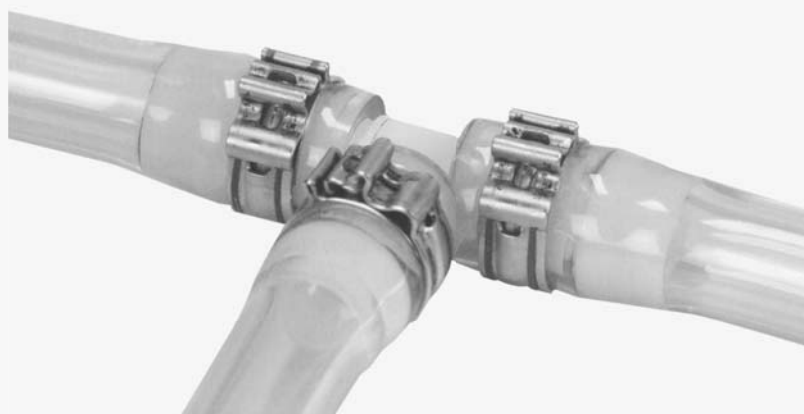
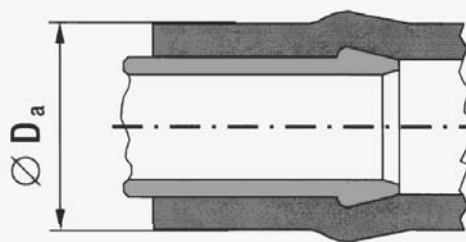

# IHCBS

## CONTINUOUS BANDING SYSTEM



**Construction:**

- Stainless steel band with rounded edges
- Available in 30 metre coils
- Matching buckles (boxes of 100)
- Supplied boxed or in a waterproof plastic dispenser

**Materials:**

Product Code IHCBS

- Stainless Steel - CrNi
- 240 hour corrosion resistance in salt spray test

**Applications:**

- Versatile fastening system
- Total flexibility of band length
- Band can be double wrapped for more strength
- Hose clamping
- Fixing signs to poles
- Pipe mounting etc

30 metre Band	30 metre Band in Dispenser	Band Dimensions mm		Boxed Buckles (100)
		Width	Thickness	
IHCBS9.5	IHCBSC9.5	9.5	0.64	IHCBB9.5
IHCBS12.7	IHCBSC12.7	12.7	0.75	IHCBB12.7
IHCBS16	-	16	0.75	IHCBB16
IHCBS19	-	19	0.75	IHCBB19

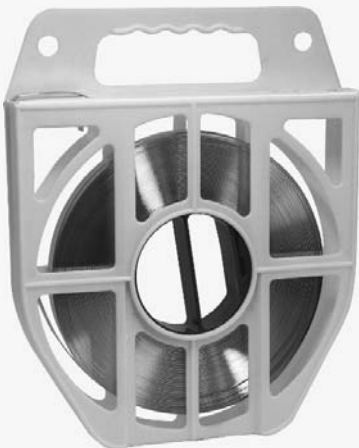

Dispenser Pack IHCBSC



Buckle IHCBB



Assembly Tool Product Code:  
IHCB-TOOL

# IHCBS

## INSTALLATION PROCEDURE CONTINUOUS BAND

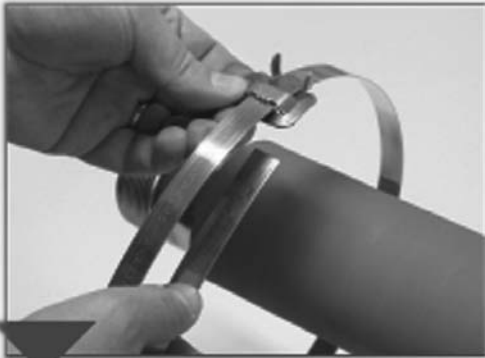

Slide the buckle onto the band with the ears pointing towards the end of the band. Form the loop of the clamp, holding band on band as illustrated, then slide the band end again through the buckle slot, bending the end approximately 25 mm under the buckle to hook it on the buckle.



For heavy duty jobs, double wrap the band

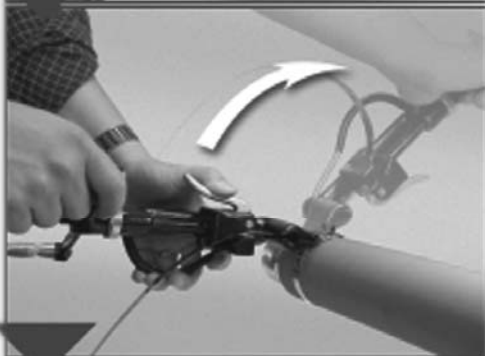

Place the band in the tool (IHCB-TOOL), push down on the gripper with the thumb, and tension the band strap by turning the handle. Maximum tension is achieved when the band stops moving through the buckle.

At this point, roll the tool over the buckle. It will be necessary to reverse the tensioning handle approximately 1/2 turn as you roll the tool over to avoid band breakage. Judicious release of the handle will prevent loss of band tension during the roll over process.

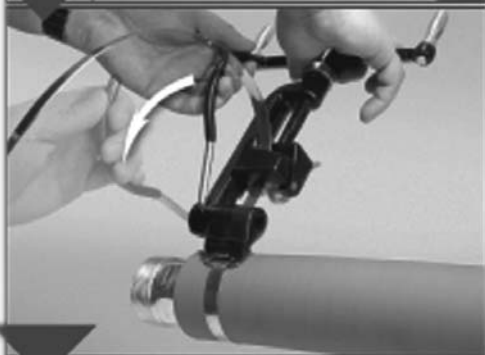

Pull on the cutting lever to cut the band off at the correct length

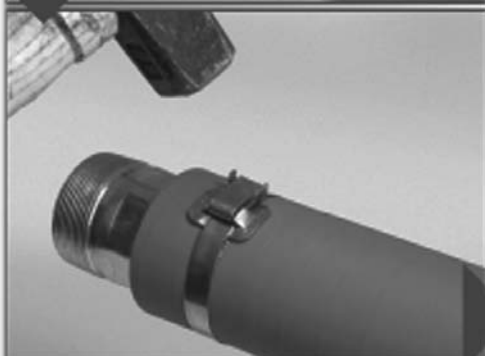

Carefully hold the severed stub with the thumb and hammer the band flat over the bridge of the buckle. Complete the clamp by hammering the ears over the band



## IHCPF

## PREFORMED CLAMPS

**Construction:**

- Stainless steel band with rounded edges
- Integrated buckle requires no hammering or crimping
- Available in boxed quantities as tabulated

**Materials:****Product Code IHCBS**

- Stainless Steel - CrNi
- 240 hour corrosion resistance in salt spray test

**Applications:**

- Quickly and easily applied
- Hose clamping
- Ideal for repetition assembly in workshops

Product Code	Max. Internal Diameter mm	Band Width	Band Thickness	Box Qty
IHCPF21-9.5	21	9.5	0.64	100
IHCPF35-9.5	35	9.5	0.64	100
IHCPF25-12.7	25	12.7	0.75	100
IHCPF32-12.7	32	12.7	0.75	100
IHCPF38-16	38	16	0.75	100
IHCPF45-16	45	16	0.75	100
IHCPF51-16	51	16	0.75	100
IHCPF57-16	57	16	0.75	100
IHCPF64-16	64	16	0.75	100
IHCPF70-19	70	19	0.75	50
IHCPF76-19	76	19	0.75	50
IHCPF89-19	89	19	0.75	50
IHCPF102-19	102	19	0.75	25
IHCPF114-19	114	19	0.75	25
IHCPF127-19	127	19	0.75	25
IHCPF152-19	152	19	0.75	25



Tool Adaptor Product Code:

IHCPF-ADP

Note that this adaptor must be used in conjunction with the Assembly Tool when installing preformed clamps

Assembly Tool Product Code:

IHCB-TOOL



# IHCPF

## INSTALLATION PROCEDURE PREFORMED CLAMPS

Place the Continuous Band Tool IHCB-TOOL in a vice and attach the Preform Adaptor IHCBF-ADP to the nose of the tool. Slip a Preformed Clamp into the tool and grip the tail end of the clamp with the eccentric lever of the main tool.

Insert the hose into the clamp and apply tension by turning the handle of the main tool. Hold the thumb on the side of the buckle where the band enters the jaws of the tool to assist in controlling the tension.

Maximum tension has been achieved when the band stops moving through the buckle.

At this point, roll the hose over until the shear hook engages behind the buckle edge. It will be necessary to reverse the tensioning handle approximately 1/4 to 1/2 turn (depending on hose diameter) as you roll the hose over to avoid band breakage. Judicious release of the handle will prevent loss of band tension during the roll over process.

(a) Pull on the cutter lever to cut the band

(b) Turn the disc by hand until tight. Use a ratchet spanner on the hex nut and operate it until the band shears



The completed Preformed Band assembly requires no hammering or crimping

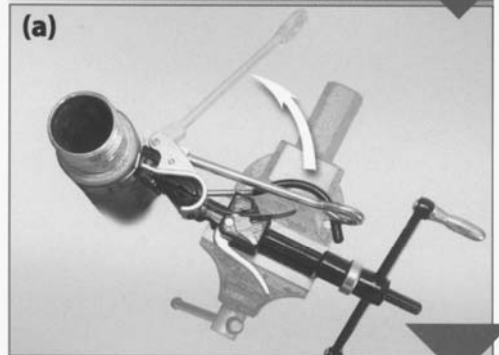
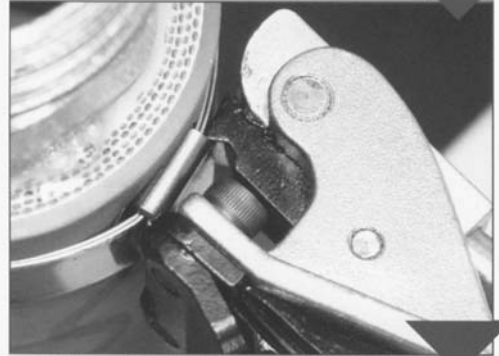
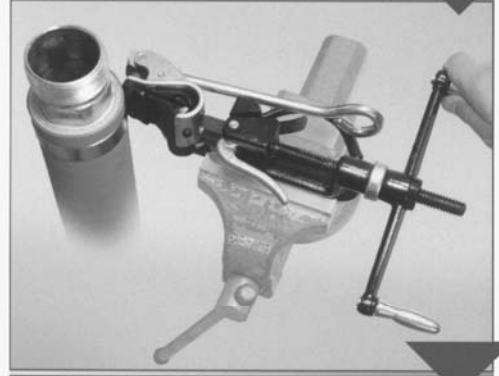
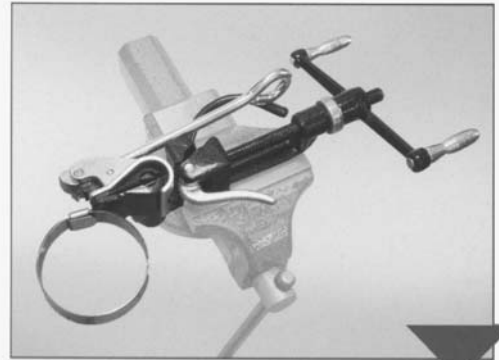

# IHCR

## RUBBER COATED CLAMPS

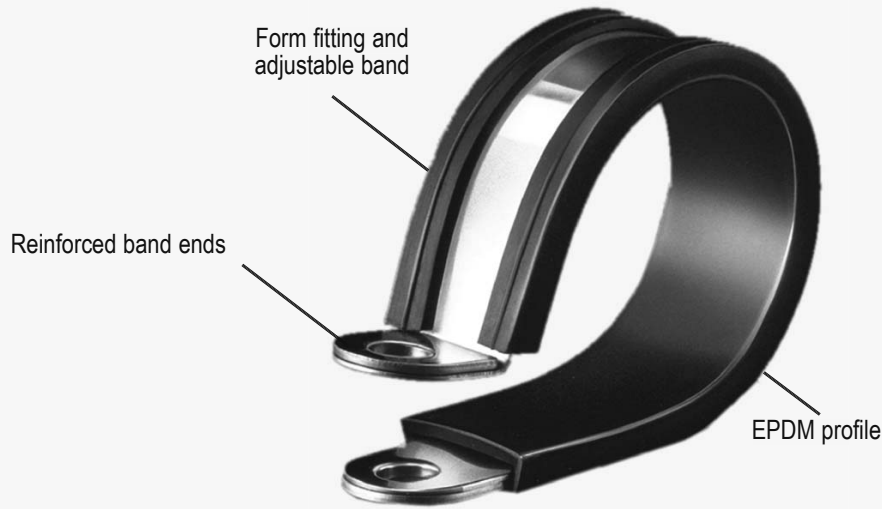

### Construction:

- Form fitting and adjustable mild steel band
- Reinforced band ends to resist tearing under high loads
- EPDM profiled rubber sleeve clip fitted tightly to the band
- 6 mm mounting holes to suit M6 bolts (not supplied)

### Materials:

#### Product Code IHCR

- Zinc plated mild steel band
- CrVI free
- 144 hour corrosion resistance in salt spray test
- EPDM profiled rubber

### Applications:

- Ideal retaining elements for pipes, cables, hoses and other applications
- Vibration damping
- Sound insulation

Product Code	Dimensions mm		
	Clamp Ø	Band Width	Bolt Hole Ø
IHCR-04	4	15	M6
IHCR-06	6	15	M6
IHCR-09	9	15	M6
IHCR-10	10	15	M6
IHCR-12	12	15	M6
IHCR-13	13	15	M6
IHCR-15	15	15	M6
IHCR-16	16	15	M6
IHCR-18	18	15	M6
IHCR-19	19	15	M6
IHCR-20	20	15	M6
IHCR-22	22	15	M6
IHCR-25	25	15	M6
IHCR-27	27	15	M6
IHCR-29	29	15	M6
IHCR-32	32	15	M6
IHCR-35	35	15	M6
IHCR-38	38	15	M6
IHCR-40	40	15	M6
IHCR-45	45	15	M6
IHCR-48	48	15	M6
IHCR-50	50	15	M6
IHCR-54	54	15	M6
IHCR-60	60	20	M6
IHCR-64	64	20	M6
IHCR-76	76	20	M6

Product Code	Dimensions mm		
	Clamp Ø	Band Width	Bolt Hole Ø
IHCRLH-13	13	19	M13
IHCRLH-16	16	19	M13
IHCRLH-19	19	19	M13
IHCRLH-22	22	19	M13
IHCRLH-25	25	19	M13
IHCRLH-32	32	19	M13
IHCRLH-36	36	19	M13
IHCRLH-38	38	19	M13
IHCRLH-43	43	19	M13
IHCRLH-47	47	19	M13
IHCRLH-51	51	19	M13
IHCRLH-64	64	19	M13



# IHCMP / IHCHP

## PVC COATED CLAMPS



### Construction:

- Black vinyl coated steel support clamps
- Plated steel for corrosion resistance
- Suitable for high ambient temperatures
- Large mounting holes to suit M10 or M13 bolts (not supplied)

### Materials:

#### Product Code IHCMP / IHCHP

- Zinc plated mild steel band
- CrVI free
- 144 hour corrosion resistance in salt spray test
- Black vinyl profile material

### Applications:

- Ideal retaining elements for pipes, cables, hoses and other applications
- Vibration damping
- Sound insulation
- Install to prevent chafing of hoses on heavy duty equipment

PVC COATED STEEL CLAMPS MEDIUM DUTY 10mm CLEARANCE HOLE			
Product Codes	Clamp Ø	Band Width	Bolt Hole Ø
IHCMP-08	8	19	10
IHCMP-10	10	19	10
IHCMP-13	13	19	10
IHCMP-14	14	19	10
IHCMP-16	16	19	10
IHCMP-18	18	19	10
IHCMP-19	19	19	10
IHCMP-20	20	19	10
IHCMP-22	22	19	10
IHCMP-24	24	19	10
IHCMP-25	25	19	10
IHCMP-27	27	19	10
IHCMP-29	29	19	10
IHCMP-32	32	19	10
IHCMP-36	36	19	10
IHCMP-38	38	19	10
IHCMP-42	42	19	10
IHCMP-44	44	19	10
IHCMP-51	51	19	10
MEDIUM DUTY 13mm LARGE HOLE			
IHCMPH-13	13	19	13
IHCMPH-17	17	19	13
IHCMPH-21	21	19	13

PVC COATED STEEL CLAMPS HEAVY DUTY 13mm CLEARANCE HOLE			
Product Codes	Clamp Ø	Band Width	Bolt Hole Ø
IHCHP-27	27	25	13
IHCHP-29	29	25	13
IHCHP-32	32	25	13
IHCHP-38	38	25	13
IHCHP-40	40	25	13
IHCHP-51	51	25	13
IHCHP-57	57	25	13
IHCHP-64	64	25	13
IHCHP-73	73	25	13

# PIPE COUPLINGS

## NORMACONNECT®

Because of the complexities and scope of the possible applications for these couplings, Pirtek do not carry them as part of their normal stock range. Pirtek can nevertheless offer a full design and installation service covering all aspects of their usage. Please consult your nearest Pirtek Service Centre

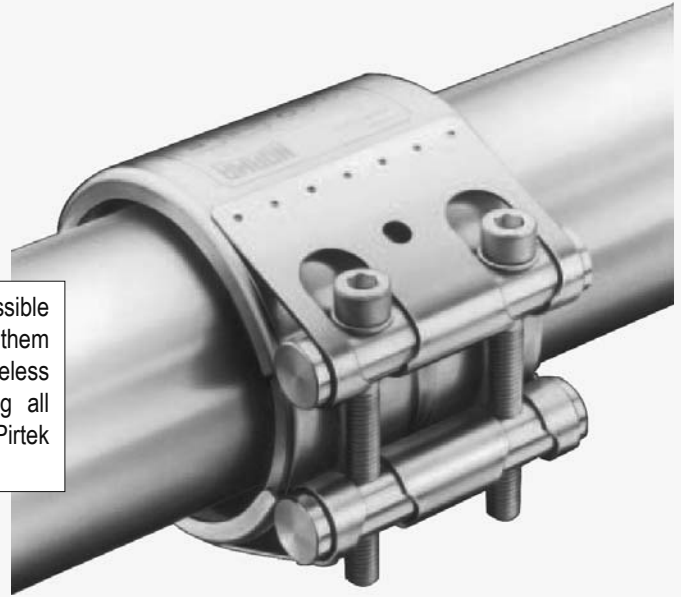

### Description:

- The NORMACONNECT® pipe coupling is a reliable connecting element for thick- and thinwalled pipes
- conforms to the latest DIN standard 86128
- Sealing reliability is also ensured under the condition of angular deflection, slight pipe misalignment and even gaps between pipe ends of up to 35 mm (refer Pirtek)
- Pressure surges, vibration and structure-born noise are absorbed to a considerable extent
- The pipe coupling is of light weight, compact and can easily be fitted even in a confined space

### Types and Sizes:

- **Types:**  
Available in several types to cater for differing pipe materials and strain loadings (see table)
- **Sizes:**  
Couplings are available to cover a range of pipe diameters from 26.9mm to 1200mm  
Larger capacities to 2032mm and 70 bar pressure subject to conditions

### Applications:

- Feed and return lines for liquids, gas and solids in industrial applications, shipbuilding, construction, fresh water supply, waste water treatment etc. – are joined quickly, easily and safely with these couplings
- An economical alternative to conventional pipe joining techniques for nearly all kind of pipe material. All plain-ended pipes can be joined in a very short period of time without welding. The ready-to-fit coupling is pushed over the pipe ends, aligned and rotated to any radial fitting position. Tightening the two bolts alternately with a torque wrench is all it takes for a safe fitting

Pipes to be Connected	Ø mm	Pressure Range bar	Strain relieved connections	Strain loaded connections			Repair
			F	G	CG	PG	R*
Metal + Metal	26.9 – 219.1	16	•	•			•
	180 – 406	10 – 2.5		•			
	180 – 1200	23.5 – 2.0	•				•
Plastic + Plastic	40 – 400	16 – 6				•	
	26.9 – 168.3	16	•				•
	180 – 1200	23.5 – 2.0	•				•
Metal + Plastic	38/40 – 400/406.4	16 – 6			•		
	26.9 – 168.3	16	•				•
	180 – 1200	23.5 – 2.0	•				•
Casting + Casting	26.9 – 168.3	16	•				•
	180 – 1200	23.5 – 2.0	•				•

\* This Coupling available from Ø 35mm



# NORMACONNECT® F

FOR STRAIN - RELIEVED  
METAL AND PLASTIC PIPES



1. Standard strip insert inlay that makes it possible to easily use the coupling even for large pipe gaps and vacuum applications. In addition, shear strength of the coupling is increased.
2. Heavy-duty lock bars of extra-large diameter are employed. This considerably improves the coupling's rigidity and the engagement of the bolts' threads
3. The protection ring protects the sealing sleeve from e. g. UV-rays, flames etc. and enhances the bending stability of the coupling
4. A patented double-lip sealing system that provides double safety

# NORMACONNECT® G

FOR STRAIN-LOADED  
METAL AND / OR PLASTIC COMBINATIONS



1. Standard strip insert inlay that makes it possible to easily use the coupling even for large pipe gaps and vacuum applications. In addition, shear strength of the coupling is increased.
2. Heavy-duty lock bars of extra-large diameter are employed. This improves the coupling's rigidity and the engagement of the bolts' threads considerably
3. Conically stamped anchoring ring with conically stamped teeth indents into the pipe surface and provides safe and strong axial restraint. Due to the special design of the anchoring ring, the coupling is even able to withstand high vibration loads
4. A patented double-lip sealing system that provides double safety
5. Available in 3 configurations of claw to cater for differing pipe materials, and with the option of an optional support for use with very soft materials such as thermoplastic pipes

# NORMACONNECT® R

REPAIR COUPLING  
FOR STRAIN - RELIEVED METAL AND PLASTIC PIPES



1. Standard strip insert inlay that makes it possible to easily use the coupling even for large pipe gaps and vacuum applications. In addition, shear strength of the coupling is increased.
2. Heavy-duty lock bars of extra-large diameter are employed. This considerably improves the coupling's rigidity and the engagement of the bolts' threads
3. A patented double-lip sealing system that provides double safety

# ALPHANUMERIC INDEX

	Page
2-Ear Clamps	7
Adaptor for Tool	12
Band Buckles	10
Band Installation	11
Band Tool	10
Buckles	10
Cobra Clips	8
Continuous Band	10
Crimping Tool	7
Dispenser Pack	10
Ear Clamps	7
Heavy Duty Clamps	5
High Torque Clamps	2-3
Hose Clamp installation	4
IHC	2-3
IHCBB	10
IHCBS	10
IHCBSC	10
IHCB-TOOL	10
IHCC	8
IHCC-TOOL	8
IHC-DRIVER	4
IHCEC	7
IHCHP	15
IHCMERMS-EMPTY	4
IHCMERMS-KIT	4
IHCMERSS-EMPTY	4
IHCMERSS-KIT	4
IHCMP	15
IHCPF	12

	Page
IHCPF-ADP	12
IHC-PINCER-N	7
IHC-PINCER-S	7
IHCR	14
IHCSS	2-3
IHCT	5
IHCTG	5-6
IHCTS	5-6
IHCWM	2-3
IHCWS	2-3
Installing Band Clamps	11
Installing Prefomed Clamps	13
Installing Worm Drives	4
Merchandisers Heavy Duty	5
Merchandisers Worm Drives	4
NormaConnect Pipe Couplings	16
Nut Driver Tool	4
Oetiker	7
Perforated Band Clamps	2-3
Prefomed Clamps	12
Professional hose clamp installation	4
Rubber / PVC Coated Clamps	14-15
Slotted Band Clamps	2-3
Solid Band Clamps	2-3
Stainless Steel Band	10
Steel Band	10
Terminology of Torque	6
Torque	6
Torro Clamps	2-3
Worm Drive Clamps (Zinc & Stainless)	2-3

